

EFX MK-V

Audio Controller

OWNER'S MANUAL

Version 1.90

Musicom 
Preserving Your Tone, Pure and Dynamic

Table of Contents

1. Introduction	3
1.1 Main Features	3
1.2 Specifications	4
1.3 Block Diagram	4
1.4 Front Panel	5
1.5 Rear Panel	6
2. Basic Operation	7
2.1 Initial Power Up	7
2.2 Preset Mode	7
2.3 Instant Access (IA) Mode	8
2.3.1 IA1 Mode	8
2.3.2 IA2 Mode	8
2.3.3 IA3 Mode	8
2.4 Mute	9
2.5 Activate/Deactivate TAP Switch	9
3. Song/Set Mode	9
3.1 Song Mode	9
3.2 Set Mode	10
4. Setup Mode	11
4.1 ORDER Menu	11
4.1.1 Changing the Effect Loop Connection Order	12
4.1.2 Making a Parallel Connection	13
4.1.3 Specify Spill Over	13
4.2 MIDI menu	14
4.2.1 Preset MIDI	14
4.2.2 Global MIDI	17
4.3 COPY Menu	19
4.3.1 Preset Copy	19
4.3.2 Bank Copy	19
4.3.3 Song Copy	20
4.3.4 Set Copy	20
4.4 TITLES Menu	21
4.4.1 Preset Titles	21
4.4.2 Song Titles	22
4.5 SONG/SET Menu	23
4.5.1 Song Edit	23
4.5.2 Set Edit	23
4.6 UTILITY Menu	24
4.6.1 Operation Mode	25
4.6.2 Click-Less	25
4.6.3 Mute Position	25
4.6.4 Max Bank Number	26
4.6.5 Duplicated PC Send	26
4.6.6 Tempo Sync With	26
4.6.7 Tempo Sync Time	27
4.6.8 XPDL Rate	27
4.6.9 Func. Switch 1-4	27
4.6.10 Loop 8/9 Return	28
4.6.11 Loop 9 Send.R Split	28
4.6.12 Holding "IA2/MUTE" Switch	28
4.6.13 Global Preset	29
4.6.14 Mute -> Loop On	29
4.6.15 Group Select	29
4.6.16 MIDI SysEx Data	30
4.6.17 Factory Reset	30
5. Cables	31
5.1 XPDL	31
5.2 Function Switches	31
6. MIDI IN Specification	32
6.1 Preset Changes	32
6.2 Individual Loop Controls	32
7. Connection Examples	33

1. Introduction

Thank you for purchasing the Musicom Lab EFX MK-V Audio Controller.

The EFX MK-V Audio Controller is the ultimate floor-based switching system.

It is a compact, easy to use, has 9 fully programmable loops, 4 function switches and a MIDI foot controller.

The EFX MK-V Audio Controller has 360 memory locations, configured as 60 banks of 6 presets, plus a global preset. It can transmit 8 MIDI Program and Control Change and messages on 8 MIDI channels and 25 MIDI Control Change messages on an appointed MIDI channel.

Also one continuous controller port(XPDL) is included and can be programmed with a designated MIDI channel and controller number.

The EFX MK-V Audio Controller has two outputs, OUT-L and OUT-R, can be used as stereo outputs, or as an A/B/Y switch for a mono guitar signal.

The EFX MK-V Audio Controller has three low-noise, high quality buffers to prevent the loss of guitar signal. Each buffer can be bypassed/engaged per each preset.

1.1 Main Features

- 9 audio loops. 7 mono loops, 2 stereo loops and 1 volume loop.
Volume Loop can be engaged/bypassed by IA switch or as parts of a preset.
- 2 stereo loops are stereo capable using TRS jacks.
- Changeable loop order per each preset.
- 3 buffers. Input buffer, Output buffer and Movable buffer.
Movable buffer can be placed anywhere in your signal path.
Each buffer can be enabled/disabled by IA switch or as parts of a preset.
- 2 internal unity mixers. each mixer has 3 input(2 Effects and Dry signal).
Mixers also are used for spillover between presets, even with your analog delay or reverb.
- 4 function switches via 2 TRS jacks. You can control the switching functions of your amp.
- 360 presets (60 banks x 6 presets) and 1 global preset.
- Create up to 99 songs
- Organize the 99 Songs into 40 sets of 40 songs
- Click-Less(Mute) function for reducing popping noise
- ISO IN and ISO OUT that prevent to occur ground hum noise and phase issue.
- Transmits 8 MIDI Program Change and 8 MIDI Control Change messages.
Each MIDI message can be stored differently in each preset.
- Transmits 25 MIDI Control Change message by assigned IA switches.
- Transmits MIDI Timing Clock and synchronizes with Function Switch3.
Tap tempo for both MIDI-compatible pedals and any pedals that have external tap input jacks.
BPM can be stored in each bank preset and song preset.
- Easily copy presets, banks, songs and sets
- 2 Lines x 24 Characters LCD display that can display preset/song titles and other status.

1.2 Specifications

- Buffer Input Impedance 2.2 M Ω
- Buffer Output Impedance 100 Ω
- Current Draw 300 mA (DC12V Center Negative)
- Dimensions 420mm(W) x 96mm(D) x 68mm(H)
16.5"(W) x 3.8"(D) x 2.7"(H)
- Weight 1,450 g / 3.2 lbs

1.3 Block Diagram

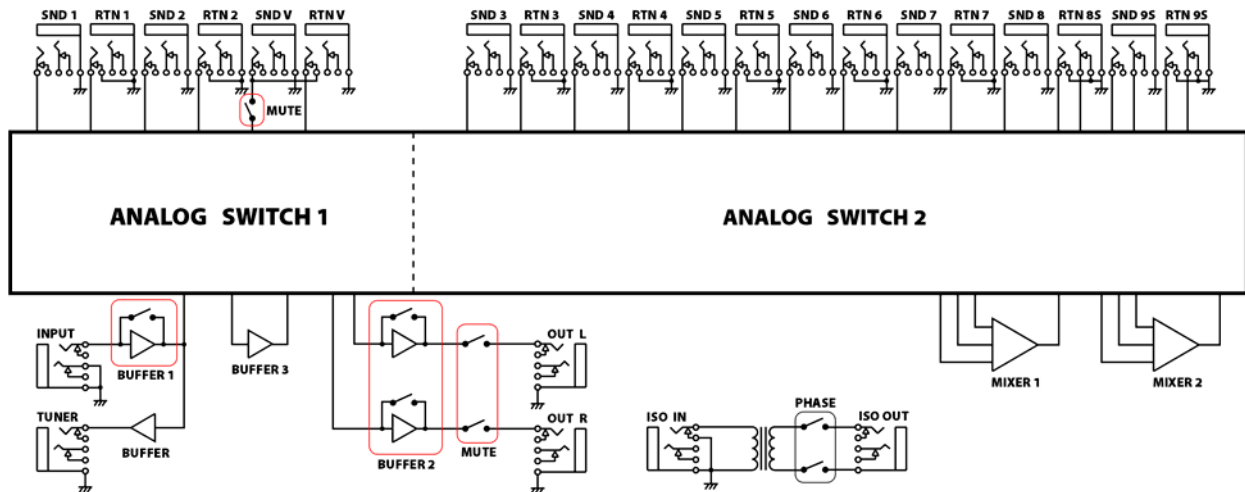

1.4 Front Panel

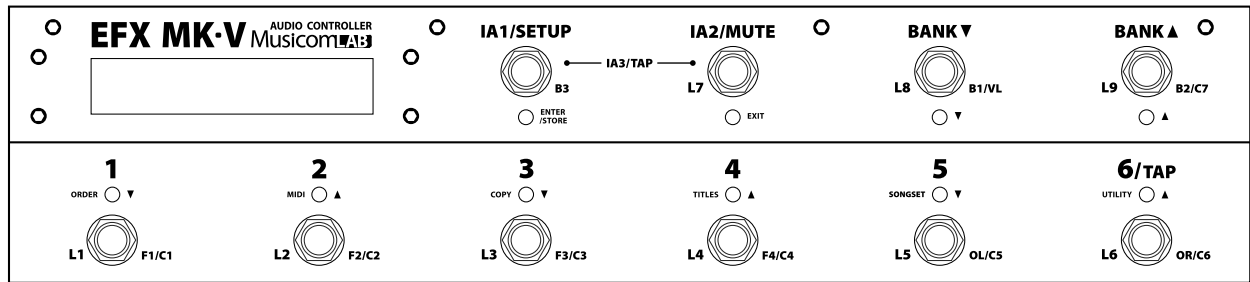

1 through 5 switches

When in Preset mode these switches are used to recall the corresponding preset. When in IA1, IA2 or IA3 mode pressing these switch turn on/off the corresponding effect loop, function switches, outputs and buffers.

6/TAP switch

This Switch can have two functions based upon your needs. By default, this button is set up to access the Preset 6, You can also program this switch to TAP TEMPO. Refer to the **Activate/Deactivate TAP Switch** on the page 8 of the manual.

BANK▲ & BANK▼

The 360 presets in the EFX MK-V are arranged in banks of 6, and these buttons allow you to select which bank of 6 you'd like to access. Pressing this switch in Preset mode decrements/increments the bank number.

IA1/SETUP

Pressing this switch puts the EFX MK-V into the IA1 mode, where you can turn individual loops on and off, and store their settings to presets. For the other side, pressing this switch for 2 seconds puts the EFX MK-V into the SETUP mode.

IA2/MUTE

Pressing this switch puts the EFX MK-V into the IA2 mode, where you can turn on function switches, buffers, and outputs. For the other side, pressing this switch for 1 seconds mutes the audio signal.

LCD Display



- Line 1 and 2 - a to d indicate a bank or song number
- Line 1 - e to g indicate a BPM number of the selected preset.
- Line 1 - i to x indicate a Preset or Song Title.
- Line 2 - f indicates a preset number within the bank or song.
- Line 2 - h to p indicate which of the 9 audio loops are currently active.
- Line 2 - r and s indicate which of the two audio outputs are active.
- Line 2 - u to x indicate which of the 4 function switches are currently active.

1.5 Rear Panel

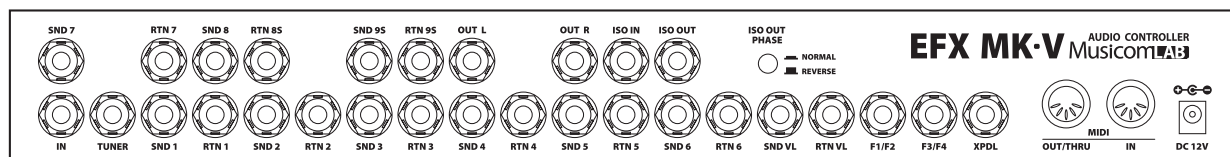

IN Jack

This is the main input jack where your guitar plugs in.

SND 1-7, RTN 1-7 Jacks

These jacks provide mono-send mono-return effect loops. SND 1–7 send signals to effect pedals. RTN 1–7 receive signals from effect pedals. Connect the SND 1–7 jacks to the INPUT jack of each effect pedal, and connect the OUTPUT jack of each effect pedal to the RTN 1–7 jacks.

SND 8, RTN 8S Jacks

These jacks provide a mono-send stereo-return effect loop. RTN 8S jack is stereo capable using TRS connectors. If the last stage of the chain is the stereo-send effect loop or the output, the signal is output in stereo. If the last effect loop in the chain is the mono-send effect loop, only the signal received at the tip conductor of the RTN 8S jack is output.

SND 9S, RTN 9S Jacks

These jacks provide a stereo-send stereo-return effect loop. These jacks are stereo capable using TRS connectors. If the last stage of the chain is the stereo-send effect loop or the output, the signal is output in stereo. If the last effect loop in the chain is the mono-send effect loop, only the signal received at the tip conductor of the RTN 9S jack is output.

SND VL, RTN VL Jacks

These jacks are for connecting a volume pedal. You can also use these jacks as send/return for a preamp.

OUT-L, OUT-R Jacks

These are the output jacks. OUT-L and OUT-R can be turned on/off independently. If the last stage of the chain is the mono output, the OUT-L signal is split up in to the OUT-R.

TUNER Jacks

This jack is for connecting an external tuner.

F1/F2, F3/F4 Jacks

Latch or momentary function switch jacks for amplifier channel switching or on/off controlling of reverbs.

TRS plug's Tip: F1 & F3

TRS plug's Ring: F2 & F4

TRS plug's Sleeve: Common ground for F1/F2 and F3/F4

XPDL Jack

An expression pedals can be connected to this jack using a 1/4" TRS cable. Also an external Tap-Tempo switch and LED to this jack using a 1/4" TRS cable. The TRS cable must be connected before supplying power to the EFX MK-V. Refer to the **5.1 XPDL** on the page 31 of the manual for cabling.

ISO-IN, ISO-OUT Jacks and ISO PHASE switch

There is an isolation transformer between ISO-IN and ISO-OUT jacks. The isolation transformer may help reduce hum that can occur when using two amps or 4CM. If ISO-IN and ISO-OUT are used, ISO-OUT can also be inverted the phase of ISO-IN by pressing the ISO OUT PHASE switch.

MIDI IN, MIDI OUT/THRU connector

MIDI IN connector receives MIDI signals from an external MIDI device. MIDI OUT/THRU connector is used to feed MIDI signals to external MIDI devices. When the operation mode of MIDI OUT/THRU has been set to 'THRU', MIDI signals received at MIDI IN pass through the EFX MK-V without any changes.

DC12V power connector

This is the main power input for the EFX MK-V. The EFX MK-V requires a DC12V supply. The current draw is approximately 300mA at DC12V (Center Negative).

2. Basic Operation

2.1 Initial Power Up

```
  a b c d e f g h i j k l m n o p q r s t u v w x
1 S/N:xxxxxxx Vx.xx TESTING
2 ..Starting PRESET Mode..
```

- Line 1 - e to j indicate the serial number of your unit.
- Line 1 - m to p indicate the firmware version of your unit.
- Line 1 - r to x indicate the power test results.
 - TEST OK* : Input Voltage is 11V-13V.
 - Too Low* : Input Voltage is under 11V.
 - Too High* : Input Voltage is over 13V.
- Line 2 - l to q indicate the operating mode (PRESET, SONG or SET01 to SET40).

The EFX MK-V requires a **DC12V** supply.

When you power up the EFX MK-V, the LCD display will show the serial number, firmware, power test results and operating Mode. And then the first preset of **Bank 01**(or **Song 01**) is selected.

2.2 Preset Mode

```
  a b c d e f g h i j k l m n o p q r s t u v w x
1 01120 Bank01 Preset1
2 01.1 ..... LR .....
```

- Line 1 and 2 - a to d indicate a bank number.
- Line 1 - e to g indicate a preset BPM.
- Line 1 - i to x indicate a preset title.
- Line 2 - e indicates that you are in the Preset mode.
- Line 2 - f indicates a preset number(1 to 6) within the bank.
- Line 2 - h to x indicate the on/off status of loops, outputs and function switches.

The EFX MK-V has 360 presets and 1 global preset that you can choose from, and they're arranged in banks of five or six. When the EFX MK-V powers up, it selects Bank 1 and Preset 1.

Press/hold **BANK▲** or **BANK▼** switch to shift other banks, pressing one of the five or six switches (**1 – 5** or **6**) selects a preset in the new bank.

- ① Press/hold the **BANK▲** or **BANK▼** switch to scroll through the 60 available banks.
- ② The LEDs above **1 - 6** switches will blink in blue.
- ③ The preset is selected via pressing any switches from **1** through **6**.
- ④ The LEDs above **1 - 6** switches will stop blinking and the LED above the switch will be turned on in blue.

For example: to select the second preset of bank 3, press the **BANK▲** or **BANK▼** switch until the bank number **3** is shown on the display. And then press the **2** switch.

The Global Preset is a preset with all the capabilities of preset 1 through 6, but is the same for all banks. Pressing the switch of a preset that is already on selects the global preset and will cause the LED above the switch to be turned off. To enable/disable the Global Preset, refer to the **"Global Preset"** on the page 29 of the manual.

2.3 IA (Instant Access) Mode

2.3.1 IA1 Mode

This mode allows you to turn each of the audio loops on or off individually. In the Preset, Song or Set mode, pressing the **IA1/SETUP** switch brings you to the IA1 mode. To left bottom of the each switch, there is a label reading L1 through L9. The following is the assignment of each switch in the IA1 Mode.

1	2	3	4	5	6/TAP	IA2/MUTE	BANK▼	BANK▲
Loop 1	Loop 2	Loop 3	Loop 4	Loop 5	Loop 6	Loop 7	Loop 8	Loop 9

Press & hold the **IA1/SETUP** switch for 1 second to store the edit and return to the Preset mode. For the other side, press the **IA1/SETUP** switch to return to the Preset mode without storing the edit.

2.3.2 IA2 Mode

This mode allows you to control 4 function switches, outputs and buffers individually. In the Preset, Song or Set mode, pressing the **IA2/MUTE** switch brings you to the IA2 mode. To first right bottom of the each switch, there is a label what the switch does in the IA2 mode. The following is the assignment of each switch in the IA2 Mode.

1	2	3	4	5	6/TAP	IA1/SETUP	BANK▼	BANK▲
Function Switch 1	Function Switch 2	Function Switch 3	Function Switch 4	Output Left	Output Right	Buffer 3 (Movable)	Buffer 1 (Input)	Buffer 2 (Output)

Press & hold the **IA2/MUTE** switch for 1 second to store the edit and return to the Preset mode. For the other side, press the **IA2/MUTE** switch to return to the Preset mode without storing the edit.

Note :

In the Preset mode, press the **IA2/MUTE** switch to enter to the IA2 mode, while pressing & holding the **IA2/MUTE** switch for 1 second to mute the guitar signal. you can set the operation of the **IA2/MUTE** switch to the contrary.

Refer to the *Holding "IA2/MUTE"* on the page 28 of the manual.

2.3.3 IA3 Mode

This Mode allows you to control the volume loop and 7 MIDI Control Change messages individually. In the Preset, Song or Set mode, pressing the **IA1/SETUP** and **IA2/MUTE** switches simultaneously brings you to the IA3 mode. To second right bottom of the each switch, there is a label what the switch does in the IA3 mode. The following is the assignment of each switch in the IA3 Mode.

1	2	3	4	5	6/TAP	BANK▼	BANK▲
C1 (MIDI CC)	C2 (MIDI CC)	C3 (MIDI CC)	C4 (MIDI CC)	C5 (MIDI CC)	C6 (MIDI CC)	Volume Loop	C7 (MIDI CC)

Press & hold the **IA1/SETUP** or **IA2/MUTE** switch for 1 second to store the edit and return to the Preset mode. For the other side, press the **IA1/SETUP** or **IA2/MUTE** switch to return to the Preset mode without storing the edit.

2.3 Mute

Press & hold the **IA2/MUTE** switch for 1 second to mute the guitar signal. When muted, the MUTE LED turns on in red. Press the **IA2/MUTE** or any switches from **1** through **6** switch to cancel the MUTE function. The mute function is not available in the IA mode.

The mute position (*VOL.LOOP* or *OUTPUT*) to be linked with this switch can be selected in UTILITY menu. Refer to the *Block Diagram* on the page 4 and the *Mute Position* on the page 26 of the manual.

2.4 Activate/Deactivate TAP Switch

The **6/TAP** switch can have two functions based upon your needs. By default, this switch is set up to access the Preset 6. You can change this switch to tap tempo function. The TAP switch function can be activated/deactivated by pressing the **IA1/SETUP** and **IA2/MUTE** switches for 1 second simultaneously.

TAP can be synchronized with MIDI Time Clock(MTC) or Function Switch 3(F3). The F3 supports for devices that only have an analog tap tempo input. Also you can select whether to send the MTC/F3 for 1 bar, 2 bars or continuously. When TAP switch function is selected, tapping the **6/TAP** switch will change the MTC or F3 rate to the tempo of your taps. At this time, the Global BPM will be changed to the tempo of your taps. When the EFX MK-V powers up, the Global BPM is 120.

Refer to the *TAP Sync With* on the page 27 and the *TAP Sync Time* on the page 28 of the manual.

3. Song / Set Mode

The Song operating mode allows access to the EFX MK-V's 99 songs. A Song is a group of 6 presets that are selected for use in a particular song. Each preset in a song can be chosen from any of the 360 presets. The Set operating mode allows up to 40 songs of the EFX Mk-V's 99 songs to be arranged in any order to create a set. The EFX MK-V can support 40 different sets.

When You are in the Song and Set mode, the **BANK▲** and **BANK▼** Switches move from song to song instead of moving from bank to bank.

Refer to the *Operating Mode* on the page 26 of the manual.

3.1 Song Mode



- Line 1 and 2 - a to d indicate a song number.
- Line 1 - e to g indicate a preset BPM in the song.
- Line 1 - i to x indicate a preset title.
- Line 2 - e indicates that you are in the Song mode.
- Line 2 - f indicates a preset number(1 to 6) within the song.
- Line 2 - h to x indicate the on/off status of loops, outputs and function switches.

- ① Press/hold the **BANK▲** or **BANK▼** switch to scroll through the 99 available songs.
- ② The LEDs above **1 - 6** switches will blink in blue and the LCD display will show the song title.
- ③ The preset is selected via pressing any switches from **1** through **6**.
- ④ The LEDs above **1 - 6** switches will stop blinking, the LED above the switch will be turned on in blue. The LCD display will show the preset title for 2 seconds and then show the song title.

For example: to select the second preset of song 3, press the **BANK▲** or **BANK▼** switch until the song number **3** is shown on the display. And then press the **2** switch.

The Global Preset is a preset with all the capabilities of preset 1 through 6, but is the same for all songs. Pressing the switch of a preset that is already on selects the global preset and will cause the LED above the switch to be turned off. To enable/disable the Global Preset, refer to the *“Global Preset”* on the page 29 of the manual.

3.2 Set Mode



- Line 1 and 2 - a to d indicate a song number.
- Line 1 - e to g indicate a preset BPM in the song.
- Line 1 - i to x indicate a preset titles.
- Line 2 - e indicates that you are in the Set mode.
- Line 2 - f indicates a preset number(1 to 6) within the song.
- Line 2 - h to x indicate the on/off status of loops, outputs and function switches.

- ① Press/hold the **BANK▲** or **BANK▼** switch to scroll through the 40 available songs.
- ② The LEDs above **1 - 6** switches will blink in blue and the LCD display will show the song title.
- ③ The preset is selected via pressing any switches from **1** through **6**.
- ④ The LEDs above **1 - 6** switches will stop blinking, the LED above the switch will be turned on in blue. The LCD display will show the preset title for 2 seconds and then show the song title.

For example: to select the second preset of song 3, press the **BANK▲** or **BANK▼** switch until the song number **3** is shown on the display. And then press the **2** switch.

The Global Preset is a preset with all the capabilities of preset 1 through 6, but is the same for all songs. Pressing the switch of a preset that is already on selects the global preset and will cause the LED above the switch to be turned off. To enable/disable the Global Preset, refer to the *“Global Preset”* on the page 29 of the manual.

4. SETUP Mode

To enter the SETUP Mode, press and hold the **IA1/SETUP** switch for 2 seconds. The display will show the following picture.



- Press the **ORDER (1)** switch to enter the Order menu.
- Press the **MIDI (2)** switch to enter the MIDI menu.
- Press the **COPY (3)** switch to enter the Copy menu.
- Press the **TITLES (4)** switch to enter the Titles menu.
- Press the **SONG/SET (5)** switch to enter the SongSet menu.
- Press the **UTILITY (6)** switch to enter the Utility menu.
- Press the **IA2/MUTE** switch to exit the SETUP mode.

4.1 ORDER Menu

The sub-menu allows changing loop structure you can make the following settings.

- Change the connection order of effect loops
- Create a parallel connection
- Specify Spill Over

The EFX MK-V has two internal mixers. By using these internal mixers, you can connect loops in parallel and use the Spill Over function.

NOTE :

- The same mixers are used for parallel connections and for Spill Over functions.
- The **Loop 1, Loop2, Volume loop** and **Movable Buffer** *CAN NOT* be used for **parallel connections** or **Spill Over functions**.
- For the mono/stereo returns of effect loops 8 and 9, Refer to the **LOOP8/9 RETURN** and **LOOP9 SEND9.R SPLIT** on the page 29 of the manual.
- The Spill Over function allows the return signal of a currently selected preset to 'Spill' into the next selected preset.

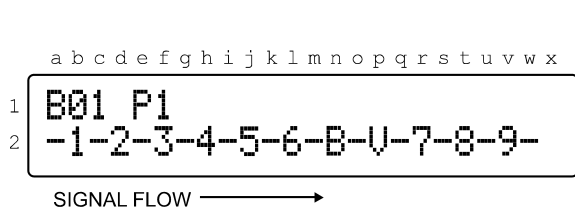

- Line 1 - b, c and f indicate the bank number and preset that you want to edit.
- Line 2 - a to w indicate the loop structure of the preset.

1 - 9	Loop Number
U	Volume Loop
B	Movable Buffer (B3)
≡ - ≡	A loop for which Spill Over is specified
-	Mono connection
=	Stereo connection

- 1 & 2** Press/hold to check the bank/preset number that current preset is located in and move/scroll a bank/preset number.
- BANK ▼** Press to activate/deactivate the Spill Over function.
- BANK ▲** Press to activate/deactivate the parallel connection with Dry signal.
- 3 & 4** Press to move cursor.
- 5 & 6** Press to move the loops number.
- ENTER/STORE (IA1/SETUP)** Press to store any changes made while in this menu.
- EXIT (IA2/MUTE)** Press to return to the SETUP menu.

4.1.1 Changing the Effect Loop Connection Order

Example : Change the order of effect loops 5 and 6.

Before the change

```

B01 P1
-1-2-3-4-5-6-B-U-7-8-9-
```

① Use the **3** or **4** switch to select the loop whose connection you want to change.

```

B01 P1
-1-2-3-4-5-6-B-U-7-8-9-
```

② Use the **5** or **6** switch to move the loop number.

```

B01 P1
-1-2-3-4-6-5-B-U-7-8-9-
```

③ Press the **IA1/SETUP** switch to store this edit.

You can change other connection orders in the same way.

4.1.2 Making a Parallel Connection

Example : Connect effect loops 8, 9 and Dry in parallel.

Before the change

```
B01 P1
-1-2-3-4-5-6-B-U-7-8-9-
```

- ① Use the **3** or **4** switch to move the cursor to the loop of the parallel connection, and press Bank **▲** switch.

```
B01 P1
-1-2-3-4-5-6-B-U-7-8-9-r7
```

- ② Use the **3** or **4** switch to select the loop whose connection you want to change.

```
B01 P1
-1-2-3-4-5-6-B-U-7-8-9-r7
```

- ③ Use the **5** or **6** switch to move the loop number.

```
B01 P1
-1-2-3-4-5-6-B-U-7-8-9-r8
```

- ④ Press the **Bank ▲** switch to mix Dry signal into this mixer.

```
B01 P1
-1-2-3-4-5-6-B-U-7-8-9-r8
```

- ⑤ Press the **IA1/SETUP** switch to store this edit.

You can change other connections in the same way.

4.1.3 Specify Spill Over

Example : You can specify Spill Over for effect loop 9.

Before the change

```
B01 P1
-1-2-3-4-5-6-B-U-7-8-9-
```

- ① Use the **3** or **4** switch to select the loops for which you want to specify Spill Over, and press **Bank ▼** switch.

```
B01 P1
-1-2-3-4-5-6-B-U-7-8-9-□
```

- ② Press the **IA1/SETUP** switch to store this edit.

You can change other Spill Over in the same way.

4.2 MIDI Menu

The MIDI menu allows accessing to the MIDI features of the EFX MK-V.

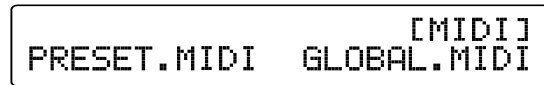

- Press the **1** switch to edit the *PRESET.MIDI* setting.
- Press the **2** switch to edit the *GLOBAL.MIDI* setting.
- Press the **IA2/MUTE** switch to exit the *MIDI* menu.

4.2.1 PRESET.MIDI

The *GLOBAL.MIDI* Menu allows defining global parameters such as ; the MIDI channel that the EFX MK-V will respond to incoming MIDI messages on, the MIDI Control Change messages that are assigned the IA Switches, expression pedal port(XPDL) MIDI Control Change Message...

1 or 2 Switch	BANK ▼ or ▲ Switch	3 or 4 Switch	5 or 6 Switch
Select Preset	PC.1	C (Channel)	01 to 16
	↕	↕	
	⋮	M (MSB)	000 to 127 or OFF
	↕	↕	
	PC.8	L (LSB)	000 to 127 or OFF
	↕	↕	
	⋮	# (Number)	001 to 128 or OFF
	↕	:	:
	CC.1	C (Channel)	01 to 16
	↕	↕	
	⋮	M (MSB)	000 to 127 or OFF
	↕	↕	
CC.8	L (LSB)	000 to 127 or OFF	
↕	↕		
⋮	# (Number)	001 to 128 or OFF	
↕	V (Value)	000 to 127 or OFF	
⋮	:	:	
↕	C (Channel)	01 to 16	
⋮	↕		
↕	# (Number)	000 to 127 or OFF	
↕	↕		
XPDL	SEL (Select)	Global or Preset	
↕	↕		
⋮	C (Channel)	01 to 16	
↕	↕		
XPDL	# (Number)	000 to 127 or OFF	
↕	↕		
⋮	VM (Value Max)	000 to 127	
↕	↕		
BPM	Vm (Value Min)	000 to 127	
	↕		
	VB (Value Begin)	000 to 127, PDL or OFF	
	↕		
	SEL (Select)	Global or Preset	
	↕		
	BPM	40 to 209 or OFF	

MIDI Program Change

a b c d e f g h i j k l m n o p q r s t u v w x

1	B01 P1	» PC.1 »
2	C:01 M:OFF L:OFF	#:001

- Line 1 - b and c indicate the bank number (01 to 60) that the preset is located in.
- Line 1 - e indicates the preset number(1 to 6 or 0 for the Global Preset) that is going to be created/modified.
- Line 1 - v indicates the MIDI Program Change (1 to 8).
- Line 2 - d and e indicate the MIDI Program Change Channel (01-16).
- Line 2 - j to k indicate the MIDI Program Change MSB (000-127 or OFF).
- Line 2 - o to q indicate the MIDI Program Change LSB (000-127 or OFF).
- Line 2 - u to w indicate the MIDI Program Change Number (001-128 or OFF).

- | | |
|--------------------------------|---|
| 1 & 2 | Press and hold to move/scroll a bank/preset number. |
| BANK ▼ & ▲ | Press and hold to move/scroll the <i>PC.1</i> to <i>BPM</i> menu. |
| 3 & 4 | Press to move cursor. |
| 5 & 6 | Press and hold to scroll a value. |
| ENTER/STORE (IA1/SETUP) | Press to store any changes made while in this menu. |
| EXIT (IA2/MUTE) | Press to return to the MIDI menu. |

MIDI Control Change

a b c d e f g h i j k l m n o p q r s t u v w x

1	B01 P1	» CC.1 »
2	C:01 #:OFF	U:000

- Line 1 - b and c indicate the bank number (01 to 60) that the preset is located in.
- Line 1 - e indicates the preset (1 to 6 or 0 for the Global Preset) that is going to be created/modified.
- Line 1 - v indicates the MIDI Control Change (1 to 8).
- Line 2 - f and g indicate the MIDI Control Change Channel (01-16).
- Line 2 - l to n indicate the MIDI Control Change Number (000-127 or OFF).
- Line 2 - s to u indicate the MIDI Control Change Value (000-127).

- | | |
|--------------------------------|---|
| 1 & 2 | Press and hold to move/scroll a bank/preset number. |
| BANK ▼ & ▲ | Press and hold to move/scroll the <i>PC.1</i> to <i>BPM</i> menu. |
| 3 & 4 | Press to move cursor. |
| 5 & 6 | Press and hold to scroll a value. |
| ENTER/STORE (IA1/SETUP) | Press to store any changes made while in this menu. |
| EXIT (IA2/MUTE) | Press to return to the MIDI menu. |

XPDL in PRESET.MIDI

```
  a b c d e f g h i j k l m n o p q r s t u v w x
1 B01 P1                « XPDL »
2  SEL:PST  C:01  #:OFF
```

- Line 1 - b and c indicate the bank number (01 to 60) that the preset is located in.
- Line 1 - e indicates the preset (1 to 6 or 0 for the Global Preset) that is going to be created/modified.
- Line 1 - v indicates that you are in the XPDL menu.
- Line 2 - g to i indicate whether the XPDL is configured as Preset (PST) or Global (GLB).
You can edit other value when PST is selected.
- Line 2 - n and o indicate the XPDL Channel (01-16).
- Line 2 - t to v indicate the XPDL Number (000-127 or OFF).

```
  a b c d e f g h i j k l m n o p q r s t u v w x
1 B01 P1                « XPDL »
2  UM:127  Um:000  UB:OFF
```

- Line 2 - e to g indicate the highest XPDL value that the expression pedal port can transmit when its pedal is moved.
- Line 2 - m to o indicate the lowest XPDL value that the expression pedal port can transmit when its pedal is moved.
- Line 2 - u to w indicate the initial XPDL value that the expression pedal port will transmit when the preset is selected.

- | | |
|--------------------------------|---|
| 1 & 2 | Press and hold to move/scroll a bank/preset number. |
| BANK ▼ & ▲ | Press and hold to move/scroll the <i>PC.1</i> to <i>BPM</i> menu. |
| 3 & 4 | Press to move cursor. |
| 5 & 6 | Press and hold to scroll a value. |
| ENTER/STORE (IA1/SETUP) | Press to store any changes made while in this menu. |
| EXIT (IA2/MUTE) | Press to return to the MIDI menu. |

BPM in PRESET.MIDI

```
  a b c d e f g h i j k l m n o p q r s t u v w x
1 B01 P1                « BPM »
2  SEL:PST  BPM:120
```

- Line 1 - b and c indicate the bank number (01 to 60) that the preset is located in.
- Line 1 - e indicates the preset (1 to 6 or 0 for the Global Preset) that is going to be created/modified.
- Line 1 - v indicates that you are in the BPM menu.
- Line 2 - h to j indicate whether the BPM is configured as Preset (PST) or Global (GLB).
You can edit the Preset BPM when PST is selected.
- Line 2 - r to t indicate the BPM of current preset.

- | | |
|--------------------------------|---|
| 1 & 2 | Press and hold to move/scroll a bank/preset number. |
| BANK ▼ & ▲ | Press and hold to move/scroll the <i>PC.1</i> to <i>BPM</i> menu. |
| 3 & 4 | Press to move cursor. |
| 5 & 6 | Press and hold to scroll a value. |
| ENTER/STORE (IA1/SETUP) | Press to store any changes made while in this menu. |
| EXIT (IA2/MUTE) | Press to return to the MIDI menu. |

XPDL in GLOBAL.MIDI

a b c d e f g h i j k l m n o p q r s t u v w x

1	« XPDL »
2	C:01 #:OFF UM:127 Um:000

- Line 1 - s to v indicate that you are in the Global XPDL.
- Line 2 - c and d indicate the Global XPDL Channel (01-16).
- Line 2 - h to j indicate the Global XPDL Number (000-127 or OFF).
- Line 2 - o to q indicate the highest XPDL value that the expression pedal port can transmit when its pedal is moved.
- Line 2 - v to x indicate the lowest XPDL value that the expression pedal port can transmit when its pedal is moved.

BANK ▼ & ▲ Press and hold to move/scroll the *CC.L1* to *OTHERS* menu.

3 & 4 Press to move cursor.

5 & 6 Press and hold to scroll a value.

ENTER/STORE (IA1/SETUP) Press to store any changes made while in this menu.

EXIT (IA2/MUTE) Press to return to the MIDI menu.

OTHERS (RECEIVE CHANNEL & OUT/THRU)

a b c d e f g h i j k l m n o p q r s t u v w x

1	« OTHERS »
2	RECV.CH:01 OUT/THRU:OUT

- Line 1 - q to v indicate that you are in the OTHERS.
- Line 2 - i and j indicate the MIDI Channel that the EFX MK-V will receive.
- Line 2 - u to x indicate the MIDI OUT or MIDI THRU.

BANK ▼ & ▲ Press and hold to move/scroll the *CC.L1* to *OTHERS* menu.

3 & 4 Press to move cursor.

5 & 6 Press and hold to scroll a value.

ENTER/STORE (IA1/SETUP) Press to store any changes made while in this menu.

EXIT (IA2/MUTE) Press to return to the MIDI menu.

4.3 COPY Menu

The Copy Menu allows copying presets, banks, songs and sets from one location to another.

```
                [COPY]
PRESET  BANK  SONG  SET
```

- Press the **1** switch to Copy *PRESET*.
- Press the **2** switch to Copy *BANK*.
- Press the **3** switch to Copy *SONG*.
- Press the **4** switch to Copy *SET*.
- Press the **IA2/MUTE** switch to exit the *COPY* menu.

4.3.1 PRESET COPY

The sub-menu allows a single preset to be copied from on preset location to another.

```
  a b c d e f g h i j k l m n o p q r s t u v w x
1  [                [COPY]
2  B01 P1 TO B01 P1
```

- Line 2 - e, f and i indicate the preset that is going to be copied.
- Line 2 - q, r and u indicate the destination preset location to copy to.

- | | |
|--------------------------------|---|
| 1 & 2 | Press and hold to move/scroll a preset that is going to be copied. |
| 3 & 4 | Press and hold to move/scroll a destination preset location to copy to. |
| ENTER/STORE (IA1/SETUP) | Press to copy any changes made while in this menu.. |
| EXIT (IA2/MUTE) | Press to return to the COPY menu. |

4.3.2 BANK COPY

The sub-menu allows an entire bank of six presets to be copied from one bank location to another.

```
  a b c d e f g h i j k l m n o p q r s t u v w x
1  [                [COPY]
2  BANK 01 TO BANK 01
```

- Line 2 - h and i indicate the bank (01 to 60) that is going to be copied.
- Line 2 - u and v indicate the destination bank location to copy to.

- | | |
|--------------------------------|---|
| 1 & 2 | Press and hold to move/scroll a bank that is going to be copied. |
| 3 & 4 | Press and hold to move/scroll a destination bank location to copy to. |
| ENTER/STORE (IA1/SETUP) | Press to copy any changes made while in this menu.. |
| EXIT (IA2/MUTE) | Press to return to the COPY menu. |

4.3.3 SONG COPY

The sub-menu allows a song to be copied from one song location to another. This sub-menu copies the presets and locations associated with the song to be copied.

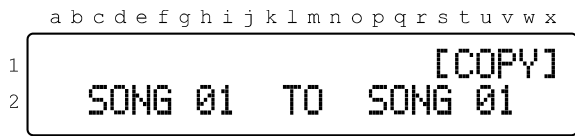

- Line 2 - h and i indicate the song (01 to 99) that is going to be copied.
- Line 2 - u and v indicate the destination song location (01 to 99) to copy to.

- 1 & 2** Press and hold to move/scroll a song that is going to be copied.
- 3 & 4** Press and hold to move/scroll a destination song location to copy to.
- ENTER/STORE (IA1/SETUP)** Press to copy any changes made while in this menu..
- EXIT (IA2/MUTE)** Press to return to the COPY Menu.

4.3.4 SET COPY

The sub-menu allows an entire set to be copied from one set location to another. This sub-menu copies all of the songs and their order of an entire set (40 songs).

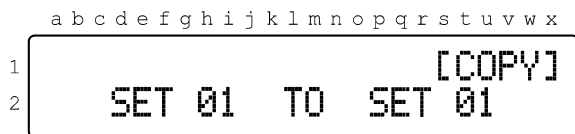

- Line 2 - h and i indicate the set (01 to 40) that is going to be copied.
- Line 2 - t and u indicate the destination set location (01 to 40) to copy to.

- 1 & 2** Press and hold to move/scroll a set that is going to be copied.
- 3 & 4** Press and hold to move/scroll a destination set location to copy to.
- ENTER/STORE (IA1/SETUP)** Press to copy any changes made while in this menu..
- EXIT (IA2/MUTE)** Press to return to the COPY menu.

4.4 TITLES Menu

The Titles Menu allows custom titles to be entered for each presets and songs. Each custom preset and song title can be up to 16 characters in length.

```

[PRESET.TITLE] [SONG.TITLE] [TITLES]

```

- Press the **1** switch to edit **PRESET.TITLES**.
- Press the **2** switch to edit **SONG.TITLES**.
- Press the **IA2/MUTE** switch to exit the **TITLES** menu.

4.4.1 PRESET.TITLES

The sub-menu allows a custom preset title, up to 16 characters in length, to be created/modified for each of the all presets.

```

a b c d e f g h i j k l m n o p q r s t u v w x
1 B01 P1 _ Bank01 Preset1
2 _!"#$%&'()*+,-./01234567

```

- Line 1 - b, c and f indicate the preset that is going to be created/modified.
- Line 1 - i to x indicate the preset title.
- Line 2 - a to x indicate the available characters.

- 1 & 2** Press and hold to move/scroll a preset that is going to be modified.
- BANK ▼ & ▲** Press and hold to move cursor when creating/modifying the preset title.
- 3 & 4** Press and hold to move/scroll through the available characters.
- 5 & 6** Press and hold to move/scroll through the available other characters.

```

!"#$%&'()*+,-./01234567
89:;<=>?@ABCDEFGHIJKLMNO
PQRSTUVWXYZ[#]^_`abcdefg
hijklmnopqrstuvwxyz{|}

```

- ENTER/STORE (IA1/SETUP)** Press to store any changes made while in this menu.
- EXIT (IA2/MUTE)** Press to return to the TITLES menu.

4.4.2 SONG.TITLES

The sub-menu allows a custom song title, up to 16 characters in length, to be created/modified for each of the all 99 songs.

```

a b c d e f g h i j k l m n o p q r s t u v w x
1 SONG01          Song 01
2 _!"#$%&'()*+,-./01234567

```

- Line 1 - e and f indicate the song that is going to be modified.
- Line 1 - i to x indicate the song title.
- Line 2 - a to x indicate the available characters.

- 1 & 2** Press and hold to move/scroll a song that is going to be modified.
- BANK ▼ & ▲** Press and hold to move cursor when creating/modifying the song title.
- 3 & 4** Press and hold to move/scroll through the available characters.
- 5 & 6** Press and hold to move/scroll through the available other characters.

```

!"#$%&'()*+,-./01234567
89:;<=>?@ABCDEFGHIJKLMNO
PQRSTUVWXYZ[^\_`abcdefg
hijklmnopqrstuvwxyz{|}

```

- ENTER/STORE (IA1/SETUP)** Press to store any changes made while in this menu.
- EXIT (IA2/MUTE)** Press to return to the TITLES menu.

4.5 SONG/SET Menu

The Song/Set Menu allows for the MK-V's regular presets to be organized in a custom bank to create a song (or custom bank of presets). Multiple songs can then be arranged in a bank in order to create a set.

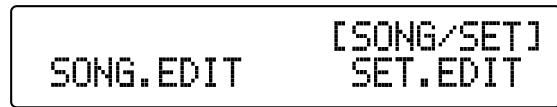

- Press the **1** switch to create/edit **SONG**.
- Press the **2** switch to create/edit **SET**.
- Press the **IA2/MUTE** switch to exit the **SONG/SET** menu.

4.5.1 SONG.EDIT

The sub-menu allows you to create a song (custom bank of presets) by assigning 6 presets. Each song contains 6 presets. The EFX MK-V can support 99 songs.



- Line 1 - b and c indicate the song number (01 to 99).
- Line 1 - f indicates the preset within the song that is going to be created/edited.
- Line 1 - n to p indicates the BPM of the song preset. (40-209, PST or GLB)
 PST : The preset of this song is recalled from the Preset BPM.
 GLB : The preset of this song is recalled from the Global BPM.
- Line 2 - t and u indicate the bank number (01 to 60) that the original preset is located in.
- Line 2 - x indicates the preset number in the above bank to be used in the song.
- Line 2 - i to x indicate the preset title.

- 1 & 2** Press and hold to scroll a song/preset number.
- 3 & 4** Press and hold to scroll the BPM of preset within in the song.
- 5 & 6** Press and hold to scroll a bank/preset number.
- ENTER/STORE (IA1/SETUP)** Press to store any changes made while in this menu.
- EXIT (IA2/MUTE)** Press to return to the SONG/SET menu.

4.5.2 SET.EDIT

The sub-menu allows songs to be arranged in a bank order to create set. The EFX MK-V can support 40 sets, they can be accessed via SET01 - SET40 Operating Modes.

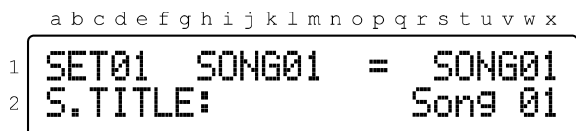

- Line 1 - d and e indicate the set number (01 to 40) that is going to be created/edited.
 - Line 1 - l and m indicate the song number (01 to 40) within the set.
 - Line 1 - w and x indicate the original song number (01 to 99) to be used in the set.
 - Line 2 - i to x indicate the song title.
- 1 & 2** Press and hold to scroll a set that is going to be created/edited.
 - 3 & 4** Press and hold to scroll a song number (01 to 40) within the set.
 - 5 & 6** Press and hold to scroll a original number (01 to 99) to be used in the set.
 - ENTER/STORE (IA1/SETUP)** Press to store any changes made while in this menu.
 - EXIT (IA2/MUTE)** Press to return to the SONG/SET menu.

4.6 UTILITY Menu

The UTILITY Menu allows configuring the EFX MK-V's general functionality by selecting its operating mode, Click-less, mute position, maximum instant access page and defining how the 4 function switches will function when used. Its sub-menu's also provide access to the data dump/load and factory default setting.

1 or 2 Switch	3 or 4 Switch
OPERATING MODE	PRESET, SONG or SET01 to SET40
⇕	
CLICK-LESS	OFF, I/O BF CHANGE or ALWAYS ON
⇕	
MUTE POSITION	VOL.LOOP, OUTPUT or NO ASSIGN
⇕	
MAX BANK NUMBER	1 to 60
⇕	
DUPLICATED PC SEND	ON or OFF
⇕	
TEMPO SYNC WITH	OFF, MTC, F3 or MTC+F3
⇕	
TEMPO SYNC TIME	1 BAR, 2 BARS or CONTINUE
⇕	
XPDL RATE	1ms to 50ms
⇕	
FUNC. SWITCH1 (F1)	LATCHED or MOMENTARY
⇕	
FUNC. SWITCH2 (F2)	LATCHED or MOMENTARY
⇕	
FUNC. SWITCH3 (F3)	LATCHED or MOMENTARY
⇕	
FUNC. SWITCH4 (F4)	LATCHED or MOMENTARY
⇕	
LOOP8 RETURN	MONO or STEREO
⇕	
LOOP9 RETURN	MONO or STEREO
⇕	
HOLDING "IA2/MUTE"	MUTE or IA2
⇕	
GLOBAL PRESET	ENABLE or DISABLE
⇕	
MUTE -> LOOP ON	NO ASSIGN or LOOP1 to LOOP9
⇕	
MIDI SYSEX DATA	
⇕	
FACTORY RESET	OFF to UTILITY

4.6.1 OPERATING MODE

The sub-menu allows determining the operating mode of the EFX MK-V.

```
  a b c d e f g h i j k l m n o p q r s t u v w x
1  [UTILITY]
2  OPERATING MODE:  PRESET
```

- Line 2 - s to x indicate the operating mode (PRESET, SONG or SET01 to SET40).

- 1 & 2** Press to advance to the previous/next Utility menu.
- 3 & 4** Press to scroll through and select the desired operating mode.
- ENTER/STORE (IA1/SETUP)** Press to store any changes made while in this menu..
- EXIT (IA2/MUTE)** Press to exit to the UTILITY menu.

4.6.2 CLICK-LESS

The CLICK-LESS control is excellent for reducing this a popping noise. The sub-menu allows determining the CLICK-LESS function.

```
  a b c d e f g h i j k l m n o p q r s t u v w x
1  [UTILITY]
2  CLICK-LESS:      OFF
```

- Line 2 - v to x indicate the CLICK-LESS status (OFF, I/O BF CHANGE or ALWAYS ON).
- OFF - You don't use the CLICK-LESS function.
- I/O BF CHANGE - The CLICK-LESS function is performed when Input or Output buffer status is changed.
- ALWAYS ON - The CLICK-LESS function is performed when a preset or IA status is changed.

- 1 & 2** Press to advance to the previous/next Utility menu.
- 3 & 4** Press to switch/toggle the CLICK-LESS control.
- ENTER/STORE (IA1/SETUP)** Press to store any changes made while in this menu..
- EXIT (IA2/MUTE)** Press to exit to the UTILITY menu.

4.6.3 MUTE POSITION

This sub-menu allows for the selection of the mute circuit to be activated by turning on the MUTE switch. Refer to the *Block Diagram* on the page 4.

```
  a b c d e f g h i j k l m n o p q r s t u v w x
1  [UTILITY]
2  MUTE POSITION:    VOL.LOOP
```

- Line 2 - o to x indicate the MUTE position (VOL.LOOP, OUTPUT or NO ASSIGN).

- 1 & 2** Press to advance to the previous/next Utility menu.
- 3 & 4** Press to select the desired mute position (VOL.LOOP, OUTPUT or NO ASSIGN).
- ENTER/STORE (IA1/SETUP)** Press to store any changes made while in this menu.
- EXIT (IA2/MUTE)** Press to exit to the UTILITY menu.

4.6.4 MAX BANK NUMBER

This menu blocks to access to bank number in the preset mode.

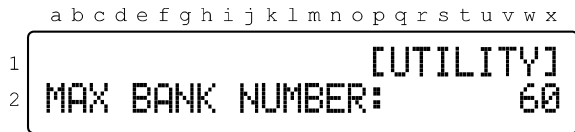

- Line 2 - w and x indicate the maximum bank number (01 to 60).

- 1 & 2** Press to advance to the previous/next Utility menu.
- 3 & 4** Press and hold to scroll a maximum bank number.
- ENTER/STORE (IA1/SETUP)** Press to store any changes made while in this menu.
- EXIT (IA2/MUTE)** Press to exit to the UTILITY menu.

4.6.5 DUPLICATED PC SEND

The sub-menu allows determining the transmission of MIDI Program Change message when current MIDI Program Change number equates with previous one.



- Line 2 - v to x indicate the DUPLICATED PC SEND status (ON or OFF).

- 1 & 2** Press to advance to the previous/next Utility menu.
- 3 & 4** Press to switch/toggle the DUPLICATED PC SEND control (ON or OFF).
- ENTER/STORE (IA1/SETUP)** Press to store any changes made while in this menu.
- EXIT (IA2/MUTE)** Press to exit to the UTILITY menu.

4.6.6 TEMPO SYNC WITH

This sub-menu allows determining where to send the TEMPO signal.

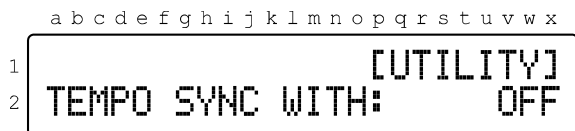

- Line 2 - q to x indicate the TEMPO SYNC WITH value (OFF, MTC, F3 or MTC+F3).
MTC: MIDI TIME CLOCK, F3:FUNCTION SWITCH3

- 1 & 2** Press to advance to the previous/next Utility menu.
- 3 & 4** Press to select the desired TEMPO SYNC WITH value.
- ENTER/STORE (IA1/SETUP)** Press to store any changes made while in this menu.
- EXIT (IA2/MUTE)** Press to exit to the UTILITY menu.

4.6.7 TEMPO SYNC TIME

This sub-menu allows determining how long the TEMPO signal outputs.

```
  a b c d e f g h i j k l m n o p q r s t u v w x
1  [UTILITY]
2  TEMPO SYNC TIME:  1 BAR
```

- Line 2 - q to x indicate the TEMPO SYNC TIME value (1 BAR, 2 BARS or CONTINUE).

- 1 & 2** Press to advance to the previous/next Utility menu.
- 3 & 4** Press to select the desired TEMPO SYNC TIME value.
- ENTER/STORE (IA1/SETUP)** Press to store any changes made while in this menu.
- EXIT (IA2/MUTE)** Press to exit to the UTILITY menu.

4.6.8 XPDL RATE

The XPDL Rate parameter provides a selectable rate at which the EFX MK-V will sample the pedal position and send out MIDI Control Change messages. The XPDL Rate parameter is adjustable from 1 to 50ms. The lower the value selected, the faster the transmission. However, the rate may need to be slowed down for devices where an error may occur from receiving MIDI messages faster than a rate that the device can process.

```
  a b c d e f g h i j k l m n o p q r s t u v w x
1  [UTILITY]
2  XPDL RATE:      10 ms
```

- Line 2 - t and u indicate the XPDL RATE value (01-50 ms).

- 1 & 2** Press to advance to the previous/next Utility menu.
- 3 & 4** Press to select the desired XPDL RATE value.
- ENTER/STORE (IA1/SETUP)** Press to store any changes made while in this menu.
- EXIT (IA2/MUTE)** Press to exit to the UTILITY menu.

4.6.9 FUNC. SWITCH 1 - 4

The FS1 to FS4 will act as footswitches like those used for amp channel switching. The EFX MK-V supports both standard switch types, latched and momentary. The sub-menu allows the selection of the function switches type.

```
  a b c d e f g h i j k l m n o p q r s t u v w x
1  [UTILITY]
2  FUNC. SWITCH1:  LATCHED
```

- Line 2 - m indicates which function switch (1 to 4) is going to be edited.
- Line 2 - o to x indicate the function switch type (LATCHED or MOMENTARY).

- 1 & 2** Press to advance to the previous/next Utility menu.
- 3 & 4** Press to switch/toggle the function switch type (LATCHED or MOMENTARY).
- ENTER/STORE (IA1/SETUP)** Press to store any changes made while in this menu.
- EXIT (IA2/MUTE)** Press to exit to the UTILITY menu.

4.6.10 LOOP 8/9 RETURN

This sub-menu allows determining whether effect loop 8 and 9 are mono-return or stereo-return.

```
  a b c d e f g h i j k l m n o p q r s t u v w x
1  [UTILITY]
2  LOOP8 RETURN:      MONO
```

- Line 2 - e indicates whether it is the LOOP8 or LOOP9.
- Line 2 - s to x indicate whether the selected loop is MONO or STEREO.

- 1 & 2** Press to advance to the previous/next Utility menu.
- 3 & 4** Press to switch/toggle the MONO or STEREO.
- ENTER/STORE (IA1/SETUP)** Press to store any changes made while in this menu.
- EXIT (IA2/MUTE)** Press to exit to the UTILITY menu.

4.6.11 LOOP 9 SEND.R SPLIT

This sub-menu allows determining whether the SND9L signal is split in to the SND9R.

```
  a b c d e f g h i j k l m n o p q r s t u v w x
1  [UTILITY]
2  LOOP9 SEND.R SPLIT: OFF
```

- Line 2 - v to x indicate whether the LOOP9 SEND.R is SPLIT ON or OFF from the LOOP9 SEND.L

- 1 & 2** Press to advance to the previous/next Utility menu.
- 3 & 4** Press to switch/toggle the ON or OFF.
- ENTER/STORE (IA1/SETUP)** Press to store any changes made while in this menu.
- EXIT (IA2/MUTE)** Press to exit to the UTILITY menu.

Note

When you use a Stereo IN/OUT effect pedal in the Loop 9, this menu must be **ON**.

For the other side, when you use a Mono IN/Stereo OUT or Mono IN/OUT effect pedal in the Loop 9, this menu must be **OFF**.

4.6.12 HOLDING 'IA2/MUTE' SWITCH

This sub-menu allows determining whether the EFX MK-V enters to the IA2 mode or executes MUTE function, by pressing & holding the IA2/MUTE for 1 second in the Preset mode.

```
  a b c d e f g h i j k l m n o p q r s t u v w x
1  [UTILITY]
2  HOLDING "IA2/MUTE": MUTE
```

- Line 2 - u to x indicate the MUTE or IA2.

MUTE : Pressing & holding the **IA2/MUTE** switch for 1 second will execute the **MUTE** function. Pressing the **IA2/MUTE** switch will enter you to the **IA2** mode.

IA2 : Pressing & holding the **IA2/MUTE** switch for 1 second will enter you to the **IA2** mode. Pressing the **IA2/MUTE** switch will execute the **MUTE** function.

- 1 & 2** Press to advance to the previous/next Utility menu.
- 3 & 4** Press to switch/toggle the MUTE or IA2.
- ENTER/STORE (IA1/SETUP)** Press to store any changes made while in this menu.
- EXIT (IA2/MUTE)** Press to exit to the UTILITY menu.

4.6.13 GLOBAL PRESET

This sub-menu allows determining whether you to use the Global Preset or not.

```

a b c d e f g h i j k l m n o p q r s t u v w x
1 [UTILITY]
2 GLOBAL PRESET:  ENABLE

```

- Line 2 - r to x indicate the ENABLE or DISABLE.

- 1 & 2** Press to advance to the previous/next Utility menu.
- 3 & 4** Press to switch/toggle the ENABLE or DISABLE.
- ENTER/STORE (IA1/SETUP)** Press to store any changes made while in this menu.
- EXIT (IA2/MUTE)** Press to exit to the UTILITY menu.

4.6.14 MUTE -> LOOP ON

This sub-menu allows you to turn on a specific loop when activating the mute function. This function is useful when using the Eventide H9 tuning function in the loop.

```

a b c d e f g h i j k l m n o p q r s t u v w x
1 [UTILITY]
2 MUTE → LOOP ON: NO ASSIGN

```

- Line 2 - p to x indicate the NO ASSIGN or LOOP1 to LOOP9.

- 1 & 2** Press to advance to the previous/next Utility menu.
- 3 & 4** Press to select the NO ASSIGN or LOOP1 to LOOP9.
- ENTER/STORE (IA1/SETUP)** Press to store any changes made while in this menu.
- EXIT (IA2/MUTE)** Press to exit to the UTILITY menu.

4.6.15 GROUP SELECT

This sub-menu allows you define a group of IA Switches where pressing one IA Switch of the group turns that IA switch on and turns all other IA switches in the group off. Only **CC.C1** through **CC.C7** switches can be set as a group. This feature is useful when you control the looper function of a device that can receive MIDI, or when you can scroll through a bank or preset.

```

a b c d e f g h i j k l m n o p q r s t u v w x
1 [UTILITY]
2 GROUP SELECT:  NO ASSIGN

```

- Line 2 - p to x indicate the NO ASSIGN or C1 TO C2 to C1 TO C7.

- 1 & 2** Press to advance to the previous/next Utility menu.
- 3 & 4** Press to select the NO ASSIGN or C1 TO C2 to C1 TO C7.
- ENTER/STORE (IA1/SETUP)** Press to store any changes made while in this menu.
- EXIT (IA2/MUTE)** Press to exit to the UTILITY menu.

Note

When the corresponding IA switches are grouped, the ON/OFF combination of these switches is not stored into internal memory and is used only for MIDI transmission through IA3 page.

The switches specified in groups only transfer MIDI CC On Value, The MIDI CC Off Value is not sent.

4.6.15 MIDI SYSEX DATA

This sub-menu allows the EFX MK-V user data to be dumped (transmitted) to a computer or another EFX MK-V, via this unit's MIDI OUT/THRU jack. User data will be transmitted as a MIDI sysex (system exclusive) message. Also this sub-menu allows the EFX MK-V user data to be loaded (received) from a computer or another EFX MK-V, via this unit's MIDI IN jack. User data will be received as a MIDI sysex (system exclusive) message.

```
  a b c d e f g h i j k l m n o p q r s t u v w x
1  [UTILITY]
2  MIDI SYX DATA  DUMP/LOAD
```

- 1 & 2** Press to advance to the previous/next Utility menu.
- ENTER/STORE (IA1/SETUP)** Press to start dumping
- EXIT (IA2/MUTE)** Press to exit to the UTILITY menu.

Note

When connecting the EFX MK-V to a PC, the *Roland UM-ONE* and the *M-Audio USB UNO 1x1* are recommended. These MIDI interfaces have been tested for compatibility with the EFX MK-V. The SYX file size should be **70,656 bytes**.

4.6.16 FACTORY RESET

This sub-menu allows erasing all user data in the internal EEPROM memory.

```
  a b c d e f g h i j k l m n o p q r s t u v w x
1  [UTILITY]
2  FACTORY RESET:  OFF
```

- Line 2 - v to x indicate the OFF, ALL DATA, PRESET, SONG, SET, GLB.MIDI or UTILITY.

- 1 & 2** Press to advance to the previous/next Utility menu.
- 3 & 4** Press to select the desired Factory Reset Area.
 - ALL DATA -> All memory
 - PRESET-> Preset Combination, Order, Preset Title and Preset.MIDI Memory
 - SONG -> Song and Song Title Memory
 - SET -> Set Memory
 - GLB.MIDI -> Global MIDI Memory
 - UTILITY -> Utility Memory
- ENTER/STORE (IA1/SETUP)** Press to start the factory default setting.
- EXIT (IA2/MUTE)** Press to exit to the UTILITY Menu.

5. Cables

5.1 XPDL

XPDL & Volume Pedal

The cable required is a stereo (TRS) to two mono 1/4" phone plugs. Connect the tip(stereo plug) to the pedal output, ring to the pedal input and sleeve to ground on all 3 plugs.

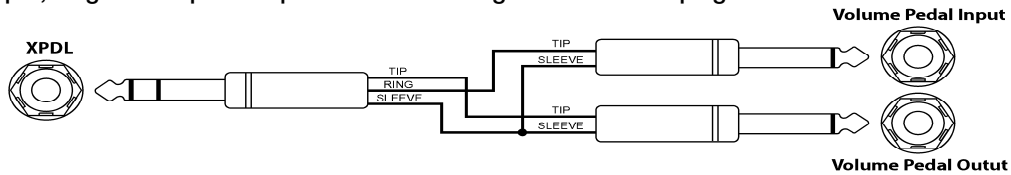

XPDL & Expression Pedal

The cable required is a stereo (TRS) to a stereo (TRS) 1/4" phone plugs.

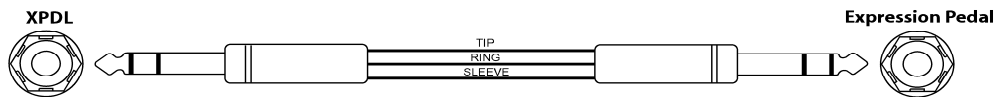

XPDL & Extenal Tap-Tempo Switch and LED

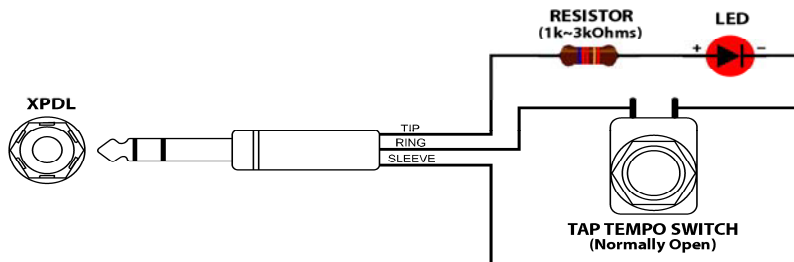

Note

The TRS cable must be connected before supplying power to the EFX MK-V.

5.2 Functions Switches

The cable required is a stereo (TRS) to two mono 1/4" phone plugs. Connect the tip(stereo plug) to the pedal input, ring to the pedal output and sleeve to ground on all 3 plugs.

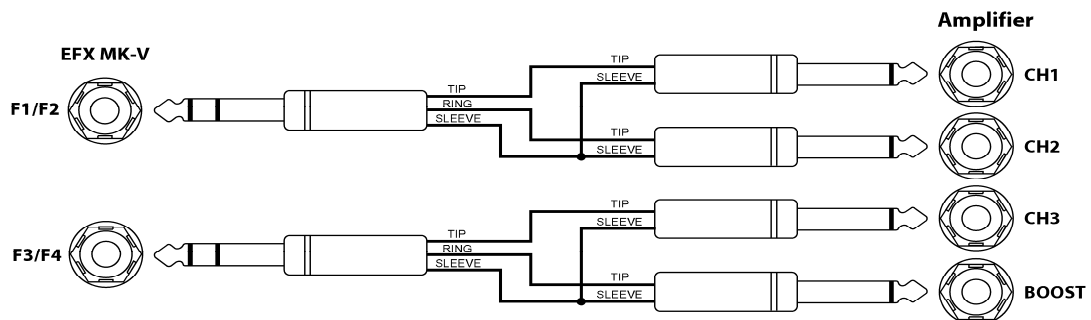

6. MIDI IN Specification

6.1 MIDI Preset Changes

MIDI access to these presets is available as MIDI program change messages. Via MIDI, the presets are numbered sequentially.

PRESET MODE		SONG MODE		SET MODE	
	CC#:0 VALUE:0		CC#:0 VALUE:0		CC#:0 VALUE:0
BANK01 - P1	PC # 001	SONG01 - P1	PC # 001	SONG01 - P1	PC # 001
BANK01 - P1	PC # 002	SONG01 - P2	PC # 002	SONG01 - P2	PC # 002
BANK01 - P1	PC # 003	SONG01 - P3	PC # 003	SONG01 - P3	PC # 003
BANK01 - P1	PC # 004	SONG01 - P4	PC # 004	SONG01 - P4	PC # 004
...	...	SONG01 - P5	PC # 005	SONG01 - P5	PC # 005
BANK22 - P1	PC # 127	SONG01 - P6	PC # 006	SONG01 - P6	PC # 006
BANK22 - P2	PC # 128				
	CC#:0 VALUE:1		CC#:0 VALUE:1		CC#:0 VALUE:1
BANK22 - P3	PC # 001	SONG02 - P1	PC # 001	SONG02 - P1	PC # 001
BANK22 - P4	PC # 002	SONG02 - P2	PC # 002	SONG02 - P2	PC # 002
...	...	SONG02 - P3	PC # 003	SONG02 - P3	PC # 003
BANK43 - P3	PC # 127	SONG02 - P4	PC # 004	SONG02 - P4	PC # 004
BANK43 - P4	PC # 128
	CC#:0 VALUE:2		CC#:0 VALUE:98		CC#:0 VALUE:39
BANK43 - P5	PC # 000	SONG99 - P1	PC # 001	SONG40 - P1	PC # 001
BANK43 - P6	PC # 001	SONG99 - P2	PC # 002	SONG40 - P2	PC # 002
...	...	SONG99 - P3	PC # 003	SONG40 - P3	PC # 003
BANK60 - P5	PC # 103	SONG99 - P4	PC # 004	SONG40 - P4	PC # 004
BANK60 - P6	PC # 104	SONG99 - P5	PC # 005	SONG40 - P5	PC # 005
		SONG99 - P6	PC # 006	SONG40 - P6	PC # 006

Note : CC#0 is the MIDI BANK SELECT MSB message.

6.2 Individual Loop Controls

The individual Loops, outputs and Function switches can be controlled with MIDI Control Change messages.

CC #	VALUE RANGE	CC #	VALUE RANGE
LOOP1	48 OFF(0-63) ON(64-127)	VOL. LOOP	57 OFF(0-63) ON(64-127)
LOOP2	49 OFF(0-63) ON(64-127)		
LOOP3	50 OFF(0-63) ON(64-127)	FUNC.SWITCH1	58 OFF(0-63) ON(64-127)
LOOP4	51 OFF(0-63) ON(64-127)	FUNC.SWITCH2	59 OFF(0-63) ON(64-127)
LOOP5	52 OFF(0-63) ON(64-127)	FUNC.SWITCH3	60 OFF(0-63) ON(64-127)
LOOP6	53 OFF(0-63) ON(64-127)	FUNC.SWITCH4	61 OFF(0-63) ON(64-127)
LOOP7	54 OFF(0-63) ON(64-127)		
LOOP8	55 OFF(0-63) ON(64-127)	OUT-L	62 OFF(0-63) ON(64-127)
LOOP9	56 OFF(0-63) ON(64-127)	OUT-R	63 OFF(0-63) ON(64-127)

7. CONNECTION EXAMPLES

Basic Mono Connection

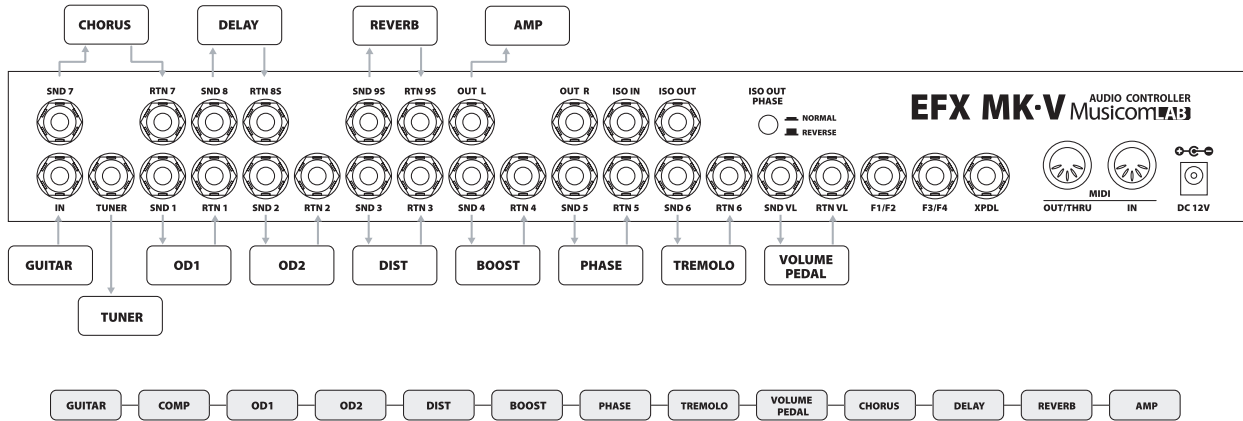

Mono Connection for 2 Amps

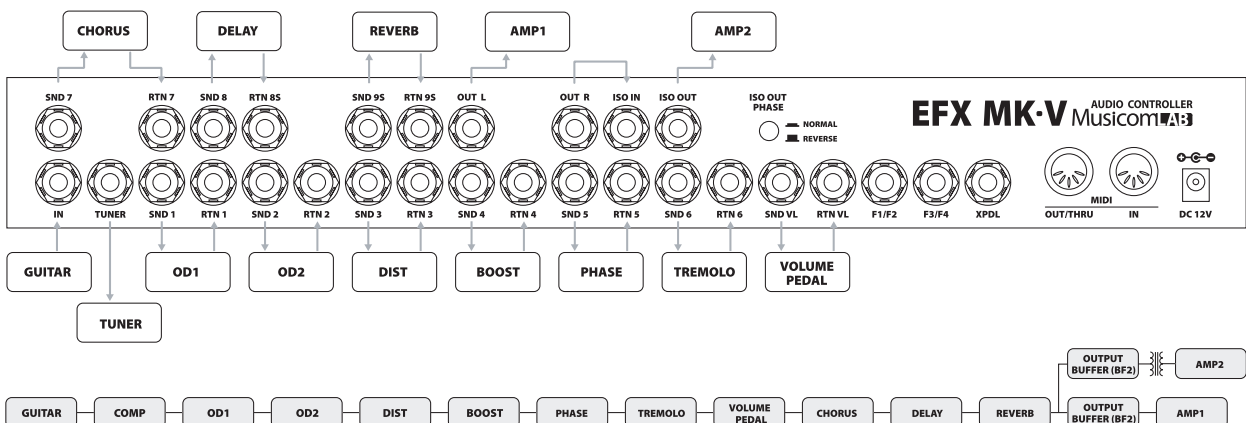

Mono Connection for 4CM

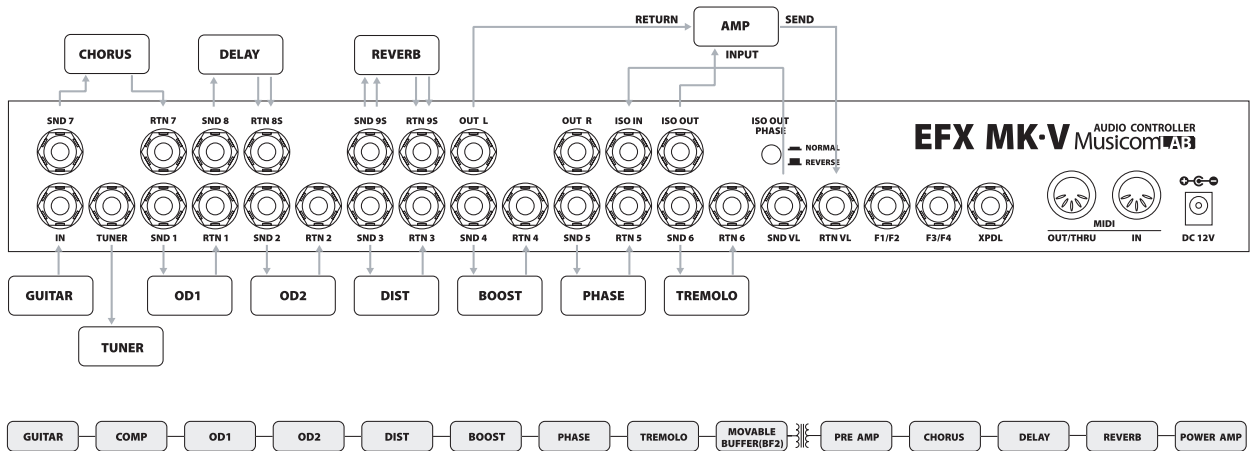

Basic Stereo Connection

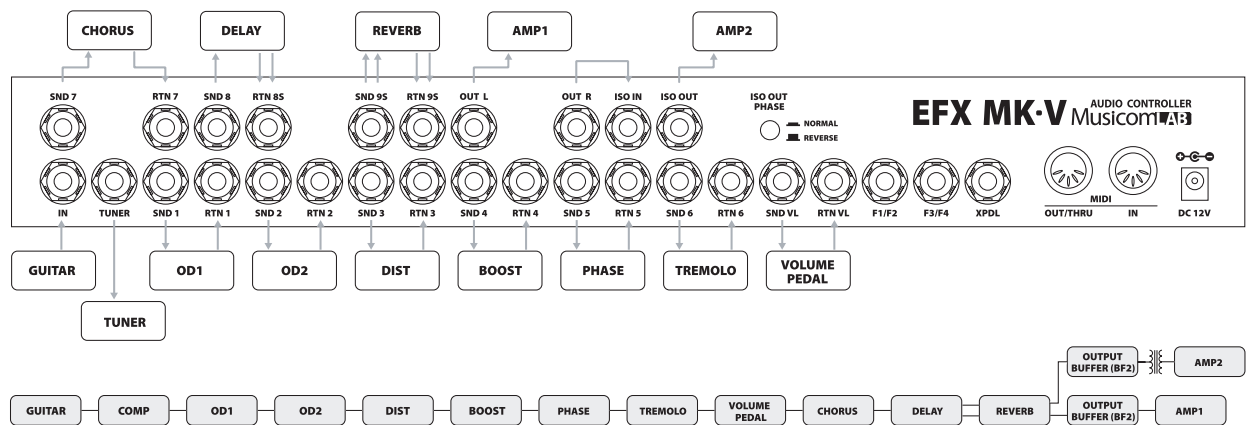

SAFETY PRECAUTIONS



WARNING

To reduce the risk of fire or electric shock, do not expose this appliance to rain or moisture.

CAUTION

To reduce the risk of fire or electric shock, do not remove screws. There are no user serviceable parts inside.
Refer servicing to qualified service personnel

WARRANTY

Musicom Lab warrants this product against any defects that are due to defective parts or faulty workmanship for a period of one year from the date of original retail purchase. During this one year period, Musicom Lab will repair it without charge for parts or labor. However shipping charges to and from the repair location must be paid by the owner.

- This warranty does not include damage to the product resulting from accident or misuse.
- This warranty shall not apply to any goods that have been repaired or altered by anyone other than the manufacturer.

Contact the following for support and/or repair service.

Mail : Musicom Lab
15-4, Seooreung-ro 15-gil, Eunpyeong-gu, Seoul, 03426, South Korea

Website : <http://www.musicomlab.com>

Email : support@musicomlab.com

Facebook : www.facebook.com/musicomlab